

YDS-PC5693-FF V2.0**5MP OmniVision OV5693 Fixed Focus USB 2.0 Camera Module**

YDS-PC5693-FF V2.0 is a 5MP Fixed Focus USB camera module based on 1/4" OV5693 image sensor. It delivers high-speed, 2K resolution ultra sharp image.

The camera has a dedicated, high-performance fixed focus function providing best-in-class image and video output. This camera module is ideal solution for drones, automotive, agriculture farming, medical equipment, and traffic monitoring.

Key Features

- 2592 x 1944 OmniVision OV5693 sensor
- High speed USB 2.0 Plug and Play
- MJPG and YUV2 output format
- Low power consumption
- Compact size
- UVC compliant to Windows, Linux, OS with UVC driver
- USB OTG (On-The-Go) support



YDS CAMERA MODULE

your best camera partner

YDS-PC5693-FF V2.0

5MP OmniVision OV5693 Fixed Focus USB 2.0 Camera Module

Camera Module No.	YDS-PC5693-FF V2.0
Resolution	5MP
Image Sensor	OV5693
Sensor Type	1/4"
Pixel Size	1.4 um x 1.4 um
EFL	3.20 mm
F.NO	2.80
Pixel	2592 x 1944
View Angle	70.0°(DFOV) 58.6°(HFOV) 45.3°(VFOV)
Lens Dimensions	8.50 x 8.50 x 5.56 mm
Module Type	Fixed Focus
Lens Model	YDS-LENS-M5182
Interface	USB 2.0
Output Format	MJPEG / YUV2
Auto Control	Saturation, Contrast, Acutance White Balance, Exposure
Audio	Yes
Input Voltage	DC 5V
Working Current	Max 500mA
PCB Size	70.00 x 8.50 mm
System Compatibility	Windows XP (SP2, SP3), Vista, 7, 8, 10, 11 Android, Mac OS, Linux or OS with UVC Driver Raspberry Pi by USB Port
Software for USB Camera	AMCAP, Webcam Viewer, V4L2 Controls Contacam, VLC Player, MotionEye OS iSpy, ZoneMider, Yawcam
Lens Type	650nm IR Cut
Operating Temperature	-30°C to +70°C
USB Cable	YDS-Cable-U001

Wide Compatibility with Windows, Android, Mac OS, Linux, or Raspberry Pi



www.YDSCAM.com sales@ydscam.com Phone (WeChat, QQ): (+86) 177 2732 6718

All rights reserved @ YingDeShun Co. Ltd. Specifications subject to change without notice.



YDS-PC5693-FF V2.0 5MP OmniVision OV5693 Fixed Focus USB 2.0 Camera Module



Top View



Side View

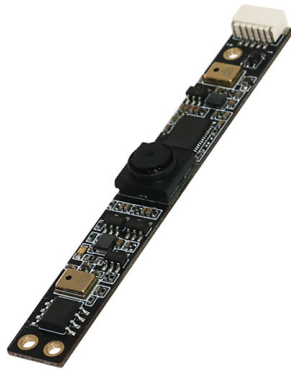

Bottom View



Mating Connector

YDS-PC5693-FF V2.0

5MP OmniVision OV5693 Fixed Focus USB 2.0 Camera Module

FORMAT	RESOLUTION	FRAME RATE
		USB 2.0
MJPG	640 x 480 (VGA)	15 FPS
	1280 x 720 (720P)	15 FPS
	1920 x 1080 (1080P)	15 FPS
	2592 x 1944 (5MP)	15 FPS
YUY2	640 x 480 (VGA)	15 FPS
	1280 x 720 (720P)	10 FPS
	1920 x 1080 (1080P)	5 FPS
	2592 x 1944 (5MP)	3 FPS





YDS CAMERA MODULE

your best camera partner



www.YDSCAM.com sales@ydscam.com Phone (WeChat, QQ): (+86) 177 2732 6718

All rights reserved @ YingDeShun Co. Ltd. Specifications subject to change without notice.



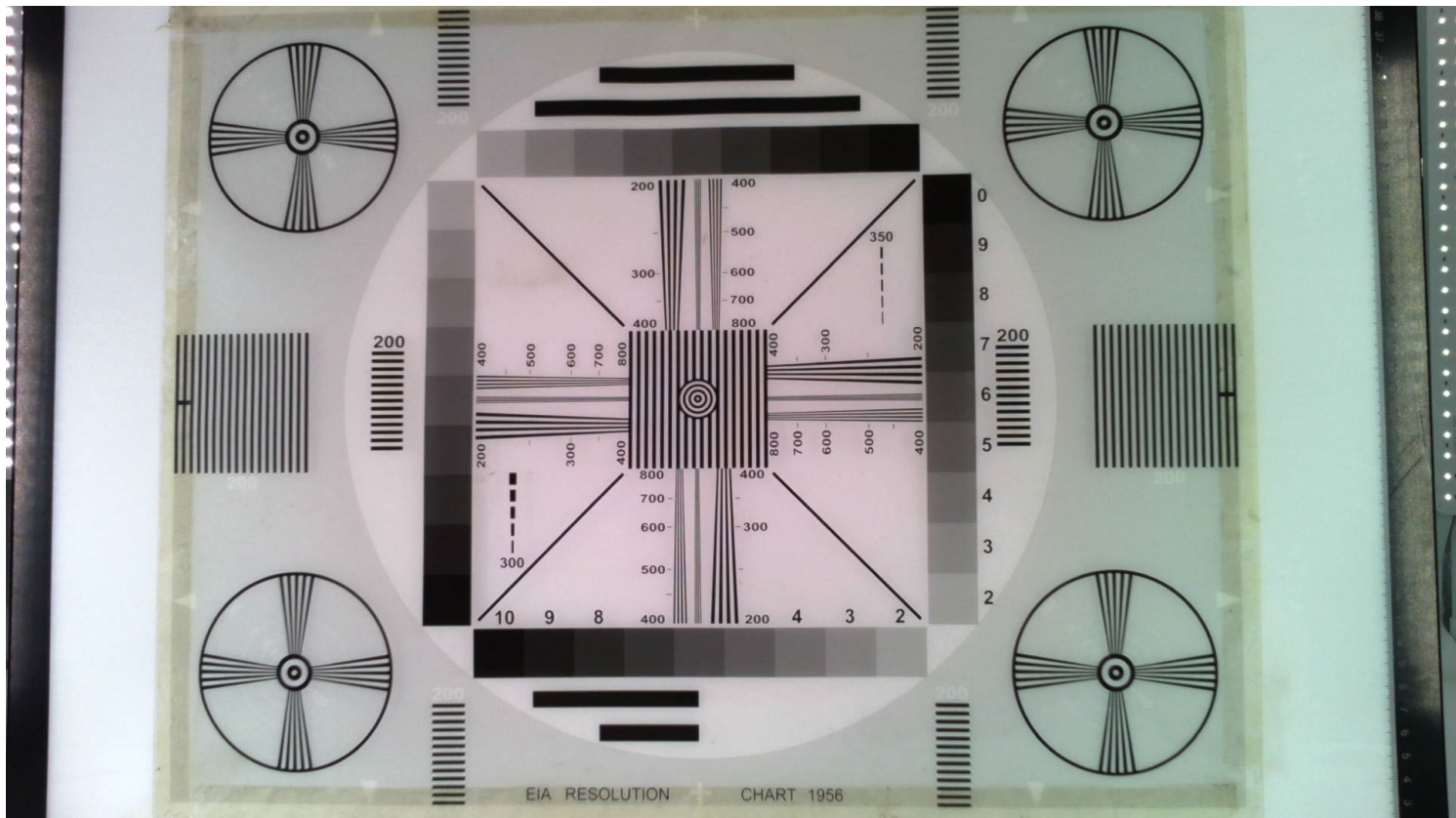
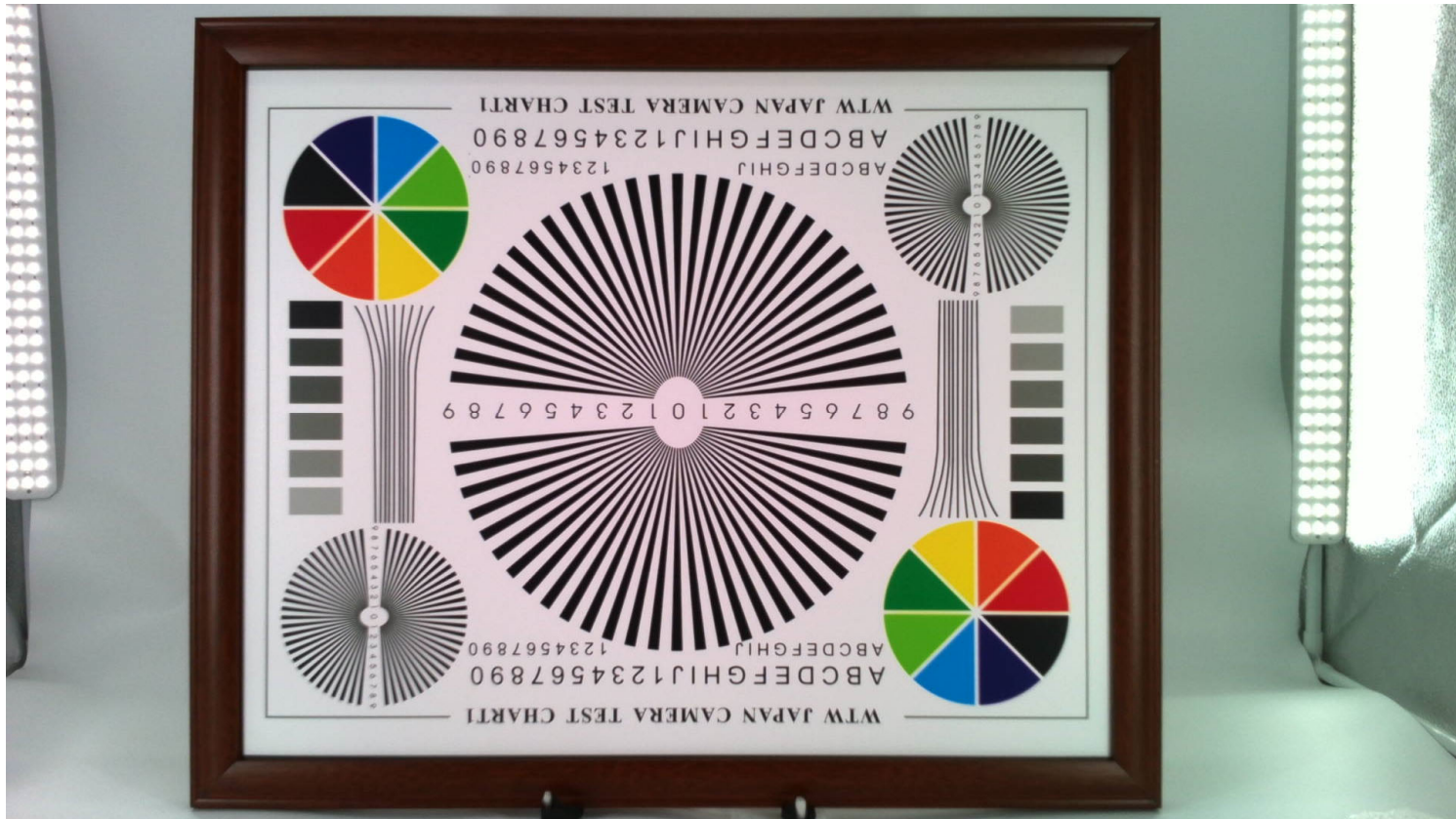



YDS CAMERA MODULE

your best camera partner

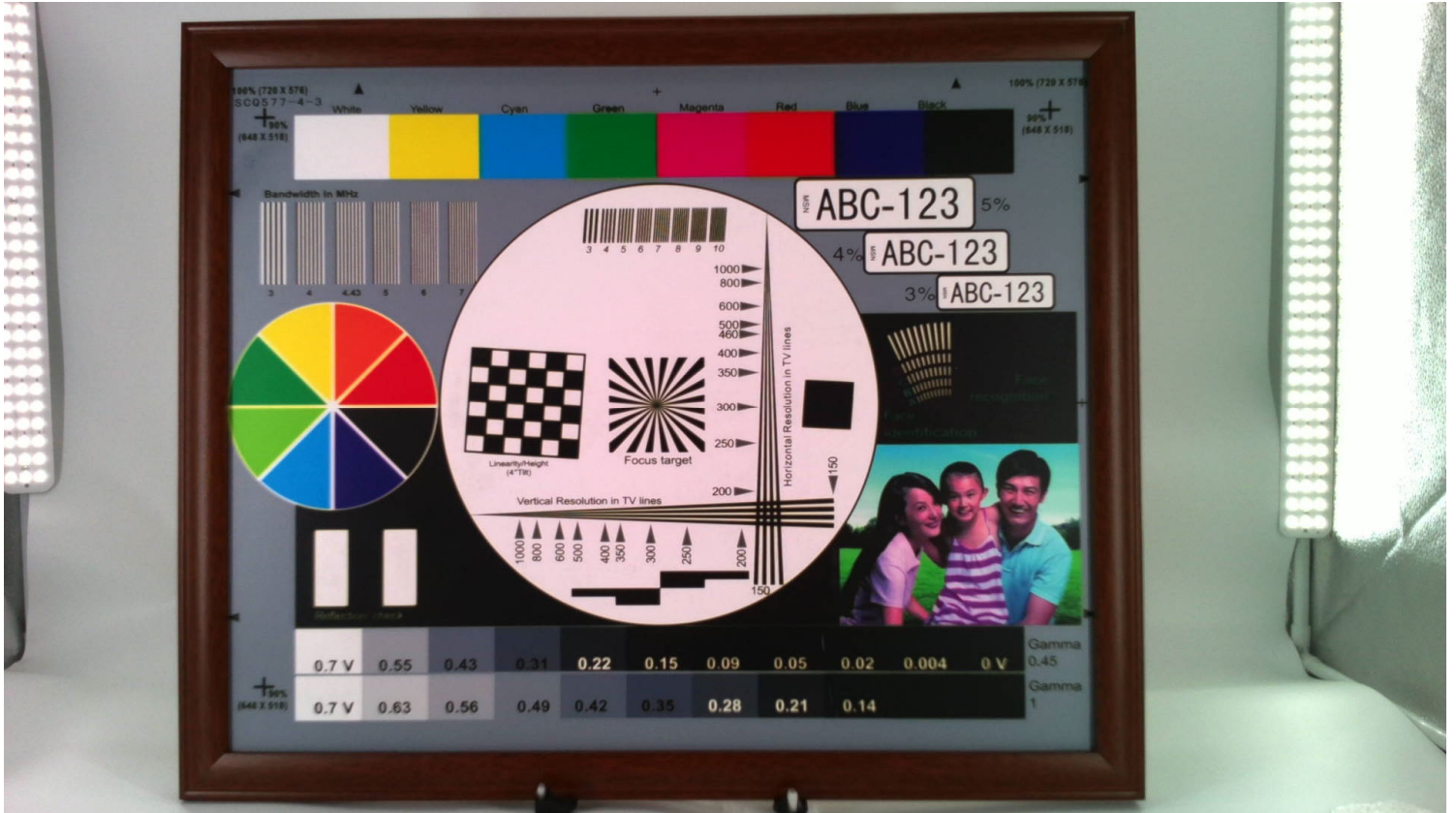

www.YDSCAM.com sales@ydscam.com Phone (WeChat, QQ): (+86) 177 2732 6718

All rights reserved @ YingDeShun Co. Ltd. Specifications subject to change without notice.

Version	Information	Date
V1.0	First Version	12-6-2021
V2.0	Add MIC	2-14-2022

PIN NO	SIGNAL
PIN1	USB 5V
02	D-
03	D+
04	GND
05	shedding GND

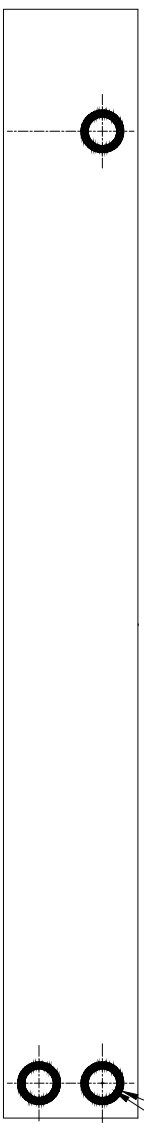

BOTTOM VIEW

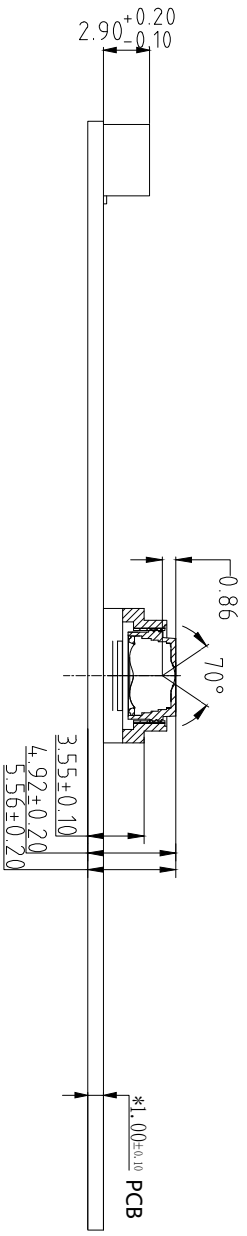

SIDE VIEW

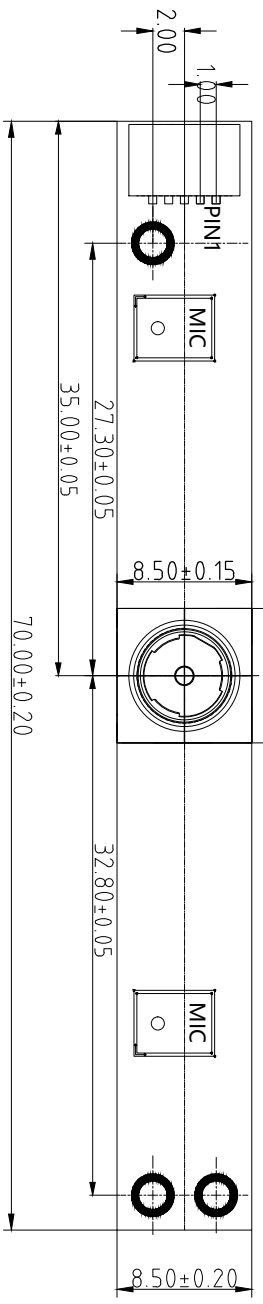

TOP VIEW

Parameters:

1、Sensor specification:

Image Sensor: OV5693
 Pixel: 1.4um×1.4um
 Lens Type: 1/4
 Important Voltage Description: USB 5V
 (External power supply);

2、Lens specification:

FOV: 70°(D);58.6°(H);45.3°(V)
 F/NO.: 2.8
 TV distortion: <1.0%
 Focal length: 3.2mm
 Composition: 4P+IR FILTER
 IR Cut Coating: 650nm±10nm@50%

Designed By	Kevin	Model Name:	PC5693-FF V2.0		
Checked By	Aouly Yan	Projection Type:	Third Angle	Unit:	mm
		Scale:	1:1	Sheet:	1 of 1
		Version:	1/0		



OV5693 5-megapixel product brief



High-Performance 5-Megapixel Image Sensor for Front-Facing Cameras in Flagship Smartphones and Tablets



available in
a lead-free
package

The OV5693 is OmniVision's highest performance 1/4-inch, 5-megapixel image sensor, delivering DSC-quality imaging and low-light performance as well as full 1080p high-definition video recording at 30 frames per second (fps). Using OmniVision's proprietary 1.4-micron OmniBSI-2™ pixel architecture, the OV5693 provides best-in-class low-light performance and image quality in a slim camera module. This makes the OV5693 an ideal camera solution for slim flagship smartphones and tablets, providing exceptional 5-megapixel "selfie" images and high-quality 1080p video.

Leveraging OmniVision's second-generation industry-leading backside illumination pixel technology, the OV5693 offers full resolution 5-megapixel images at 30 fps, an integrated scaler, and 2x2 binning

functionality with re-sampling filter. The scaler enables electronic image stabilization, while maintaining full field-of-view in both 720p and 1080p HD video modes. The 2x2 binning functionality, which features a post-binning re-sampling filter, further increases the sensor's sensitivity, while minimizing spatial artifacts and removing image artifacts around edges to produce crisp, clean color images.

The sensor features a high-speed 2-lane MIPI interface running up to 900 Mbps per lane and fits into an industry standard module size of 8.5 x 8.5 mm with a z-height of 4.2 mm for an autofocus module.

Find out more at www.ovt.com.



Applications

- Cellular and Mobile Phones
- Digital Still Cameras (DSC)
- Digital Video Camcorders (DVC)
- PC Multimedia
- 3D Cameras

Product Features

- automatic black level calibration (ABLC)
- programmable controls for frame rate, mirror and flip, cropping, windowing, and scaling
- image quality controls: lens correction and defective pixel canceling
- supports output formats: 10-bit RAW RGB (MIPI)
- supports horizontal and vertical subsampling
- supports images sizes: 5MP, EIS1080p, 1080p, 720p, VGA, QVGA
- fast mode switching
- supports 3D applications
- support 2x2 binning, full scalar
- standard serial SCCB interface
- up to 2-lane MIPI serial output interface
- embedded 512 bytes one-time programmable (OTP) memory for part identification, etc.
- two on-chip phase lock loop (PLL)
- programmable I/O drive capability
- built-in 1.2V regulator for core
- built-in temperature sensor
- supports alternate row HDR timing

OV5693



Ordering Information

- OV5693-G06H-3A**
(color, chip probing, 180 μm backgrinding, reconstructed 8" wafer with good die)
- OV5693-G36H-3A**
(color, chip probing, 180 μm backgrinding, reconstructed 12" wafer with good die)

Product Specifications

- active array size:** 2592 x 1944
- power supply:**
 - core: 1.16 - 1.3V (1.2V typical)
 - analog: 2.6 - 3.0V
 - I/O: 1.7 - 3.0V
- power requirements:**
 - active: 239 mW
 - XSHUTDOWN: 1 μW
- temperature range:**
 - operating: -30°C to +70°C junction temperature
 - stable image: 0°C to +50°C junction temperature
- output formats:** 10-bit RGB RAW
- lens size:** 1/4"
- lens chief ray angle:** 29.7° non-linear
- input clock frequency:** 6 - 27 MHz
- max S/N ratio:** 37.1 dB
- dynamic range:** 68.0 dB @ 8x gain
- maximum image transfer rate:**
 - SMP: 30 fps
 - EIS1080p: 30 fps
 - 1080p: 30 fps
- sensitivity:** 1000 mV/lux-sec
- scan mode:** progressive
- pixel size:** 1.4 μm x 1.4 μm
- dark current:** 3.3 mV/sec @ 60°C junction temperature
- image area:** 3673.6 μm x 2738.4 μm
- dimensions:**
 - COB: 5350 μm x 4800 μm
 - RW: 5400 μm x 4850 μm

Functional Block Diagram

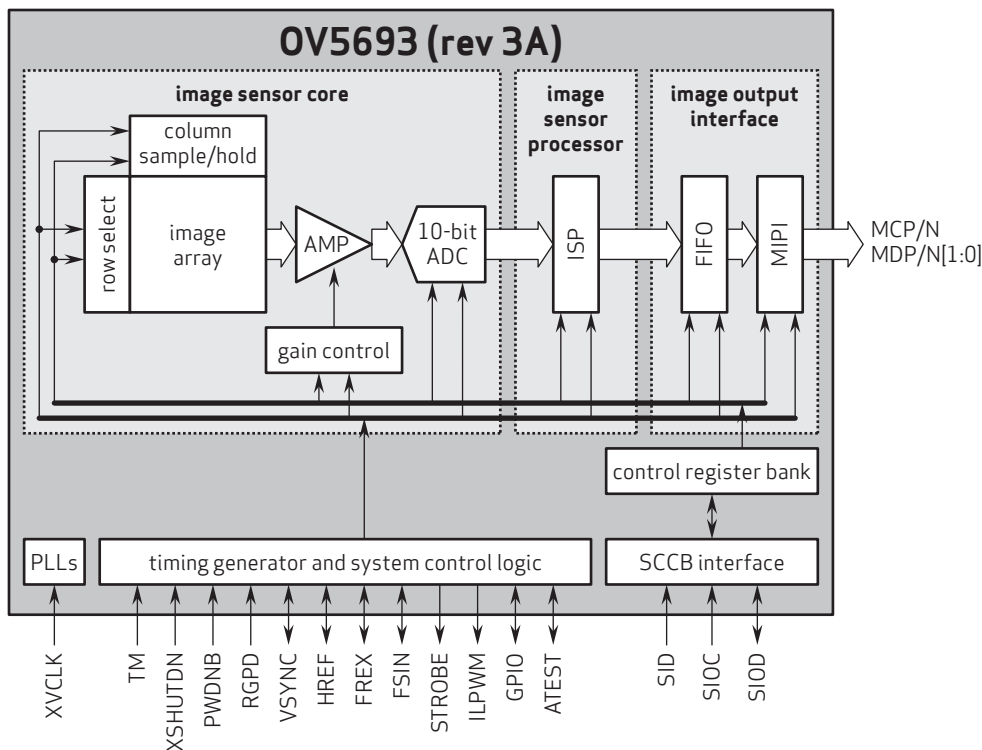

4275 Burton Drive
Santa Clara, CA 95054
USA

Tel: + 1 408 567 3000
Fax: + 1 408 567 3001
www.ovt.com

OmniVision reserves the right to make changes to their products or to discontinue any product or service without further notice. OmniVision, the OmniVision logo and OmniPixel are registered trademarks of OmniVision Technologies, Inc. OmniBSI-2 is a trademark of OmniVision Technologies, Inc. All other trademarks are the property of their respective owners.



OmniVision



YDS CAMERA MODULE

your best camera partner

Camera Module Pinout Definition Reference Chart

OmniVision	Sony	Samsung	On-Semi	Aptina	Himax	GalaxyCore	PixArt	SmartSens	Sensors	
Pin Signal										
Description										
DGND	GND									ground for digital circuit
AGND										ground for analog circuit
PCLK	DCK									DVP PCLK output
XCLR	PWDN	XSHUTDOWN	STANDBY							power down active high with internal pull-down resistor
MCLK	XVCLK	XCLK	INCK							system input clock
RESET	RST									reset active low with internal pull-up resistor
NC	NULL									no connect
SDA	SIO_D	SIOD								SCCB data
SCL	SIO_C	SIOC								SCCB input clock
VSYNC	XVS	FSYNC								DVP VSYNC output
HREF	XHS									DVP HREF output
DOVDD										power for I/O circuit
AFVDD										power for VCM circuit
AVDD										power for analog circuit
DVDD										power for digital circuit
STROBE	FSTROBE									strobe output
FSIN										synchronize the VSYNC signal from the other sensor
SID										SCCB last bit ID input
ILPWM										mechanical shutter output indicator
FREX										frame exposure / mechanical shutter
GPIO										general purpose inputs
SLASEL										I2C slave address select
AFEN										CEN chip enable active high on VCM driver IC
MIPI Interface										
MDN0	DN0	MD0N	DATA_N	DMO1N						MIPI 1st data lane negative output
MDP0	DP0	MD0P	DATA_P	DMO1P						MIPI 1st data lane positive output
MDN1	DN1	MD1N	DATA2_N	DMO2N						MIPI 2nd data lane negative output
MDP1	DP1	MD1P	DATA2_P	DMO2P						MIPI 2nd data lane positive output
MDN2	DN2	MD2N	DATA3_N	DMO3N						MIPI 3rd data lane negative output
MDP2	DP2	MD2P	DATA3_P	DMO3P						MIPI 3rd data lane positive output
MDN3	DN3	MD3N	DATA4_N	DMO4N						MIPI 4th data lane negative output
MDP3	DP3	MD3P	DATA4_P	DMO4P						MIPI 4th data lane positive output
MCN	CLKN	CLK_N	DCKN							MIPI clock negative output
MCP	CLKP	MCP	CLK_P	DCKN						MIPI clock positive output
DVP Parallel Interface										
D0	DO0	Y0								DVP data output port 0
D1	DO1	Y1								DVP data output port 1
D2	DO2	Y2								DVP data output port 2
D3	DO3	Y3								DVP data output port 3
D4	DO4	Y4								DVP data output port 4
D5	DO5	Y5								DVP data output port 5
D6	DO6	Y6								DVP data output port 6
D7	DO7	Y7								DVP data output port 7
D8	DO8	Y8								DVP data output port 8
D9	DO9	Y9								DVP data output port 9
D10	DO10	Y10								DVP data output port 10
D11	DO11	Y11								DVP data output port 11

www.YDSCAM.com sales@ydscam.com Phone (WeChat, QQ): (+86) 177 2732 6718

All rights reserved @ YingDeShun Co. Ltd. Specifications subject to change without notice.

Cameras Applications



IMAGING DEVICES



Camera Reliability Test

Reliability Inspection Item		Testing Method	Acceptance Criteria	
Category	Item			
Environmental	Storage Temperature	High 60°C 96 Hours	Temperature Chamber	No Abnormal Situation
		Low -20°C 96 Hours	Temperature Chamber	No Abnormal Situation
	Operation Temperature	High 60°C 24 Hours	Temperature Chamber	No Abnormal Situation
		Low -20°C 24 Hours	Temperature Chamber	No Abnormal Situation
	Humidity	60°C 80% 24 Hours	Temperature Chamber	No Abnormal Situation
	Thermal Shock	High 60°C 0.5 Hours Low -20°C 0.5 Hours Cycling in 24 Hours	Temperature Chamber	No Abnormal Situation
Physical	Drop Test (Free Falling)	Without Package 60cm	10 Times on Wood Floor	Electrically Functional
		With Package 60cm	10 Times on Wood Floor	Electrically Functional
	Vibration Test	50Hz X-Axis 2mm 30min	Vibration Table	Electrically Functional
		50Hz Y-Axis 2mm 30min	Vibration Table	Electrically Functional
		50Hz Z-Axis 2mm 30min	Vibration Table	Electrically Functional
	Cable Tensile Strength Test	Loading Weight 4 kg 60 Seconds Cycling in 24 Hours	Tensile Testing Machine	Electrically Functional
Electrical	ESD Test	Contact Discharge 2 KV	ESD Testing Machine	Electrically Functional
		Air Discharge 4 KV	ESD Testing Machine	Electrically Functional
	Aging Test	On/Off 30 Seconds Cycling in 24 Hours	Power Switch	Electrically Functional
	USB Connector	On/Off 250 Times	Plug and Unplug	Electrically Functional



Camera Inspection Standard

Inspection Item		Inspection Method	Standard of Inspection		
Category	Item				
Appearance	FPC/ PCB	Color	The Naked Eye	Major Difference is Not Allowed.	
		Be Torn/Chopped	The Naked Eye	Copper Crack Exposure is Not Allowed.	
		Marking	The Naked Eye	Clear, Recognizable (Within 30cm Distance)	
	Holder	Scratches	The Naked Eye	The Inside Crack Exposure is Not Allowed	
		Gap	The Naked Eye	Meet the Height Standard	
		Screw	The Naked Eye	Make Sure Screws Are Presented (If Any)	
		Damage	The Naked Eye	The Inside Crack Exposure is Not Allowed	
	Lens	Scratch	The Naked Eye	No Effect On Resolution Standard	
		Contamination	The Naked Eye	No Effect On Resolution Standard	
		Oil Film	The Naked Eye	No Effect On Resolution Standard	
		Cover Tape	The Naked Eye	No Issue On Appearance.	
	Function	Image	No Communication	Test Board	Not Allowed
			Bright Pixel	Black Board	Not Allowed In the Image Center
Dark Pixel			White board	Not Allowed In the Image Center	
Blurry			The Naked Eye	Not Allowed	
No Image			The Naked Eye	Not Allowed	
Vertical Line			The Naked Eye	Not Allowed	
Horizontal Line			The Naked Eye	Not Allowed	
Light Leakage			The Naked Eye	Not Allowed	
Blinking Image			The Naked Eye	Not Allowed	
Bruise			Inspection Jig	Not Allowed	
Resolution			Chart	Follows Outgoing Inspection Chart Standard	
Color			The Naked Eye	No Issue	
Noise			The Naked Eye	Not Allowed	
Corner Dark			The Naked Eye	Less Than 100px By 100px	
Color Resolution			The Naked Eye	No Issue	
Dimension	Height	The Naked Eye	Follows Approval Data Sheet		
	Width	The Naked Eye	Follows Approval Data Sheet		
	Length	The Naked Eye	Follows Approval Data Sheet		
	Overall	The Naked Eye	Follows Approval Data Sheet		

YDSCAM Package Solutions

YDS Camera Module



Complete with Lens Protection Film



Tray with Grid and Space



Place Cameras on the Tray



YDSCAM Package Solutions

Full Tray of Cameras



Cover Tray with Lid



Place Tray into Anti-Static Bag



Vacuum the Anti-Static Bag



YDSCAM Package Solutions

Sealed Vacuum Anti-Static Bag with Labels

1. Model and Description 2. Quantity 3. Manufacturing Date Code 4. Caution



YDSCAM Package Solutions

Place Foam Sheets Between Tray Bags



Foam Sheets are Larger Than Trays



Place Foam Sheets and Trays into Box



Foam Sheets are Tightly Fitting in Box



Seal the Carbon Box



Label the Carbon Shipping Box





YDSCAM Package Solutions

USB Camera Module

Complete with Lens Protection Film

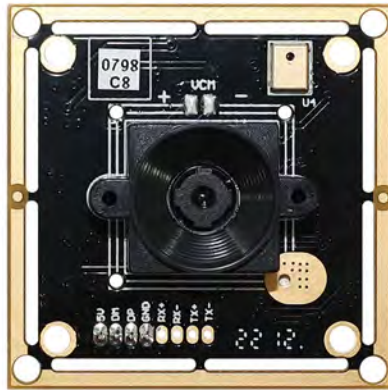

Place Camera Sample into Anti-Static Bag

Place USB Cameras into Tray



Seal the Tray with Anti-Static Bag

Label the Carbon Shipping Box



YDSCAM Package Solutions

Place Camera Sample into Anti-Static Bag



Place Connectors into Anti-Static Bag



Label the Sample Bags



Place Connectors into Reel



Place Samples into the Carbon Box



Place Connectors into the Carbon Box





YDS CAMERA MODULE

your best camera partner

Company YDSCAM

YingDeShun Co. Ltd. (YDS) was established in 2017, a next-generation technology driven manufacturer specialized in research, design, and produce of audio and video products. YDS is occupying 20,000 square feet automated plants with 100 employees of annual throughput 30,000,000 units cameras.

YDS provides OEM, ODM design, contract manufacturing, and builds the camera products. You may provide the requirements to us, even with a hand draft, our sales and engineering work together to meet your needs. We consider ourselves your last-term partner in developing practical and innovative solutions.

Our team covers everything from initial concept development to mass produced product. YDS specializes in customized camera design, raw material, electronic engineering, firmware/software development, product testing, and packing design. Our experienced strategic supply systems offer a robust and dependable manufacturing capacity for orders of various sizes.

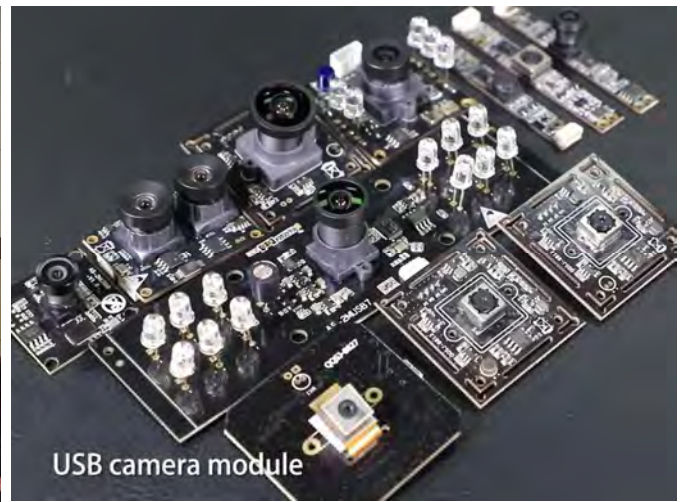

Limited Warranty

YDS provides the following limited warranty if you purchased the Product(s) directly from YDS company or from YDS's website www.YDSCAM.com. Product(s) purchased from other sellers or sources are not covered by this Limited Warranty. YDS guarantees that the Product(s) will be free from defects in materials and workmanship under normal use for a period of one (1) year from the date you receive the product ("Warranty Period").

For all Product(s) that contain or develop material defects in materials or workmanship during the Warranty Period, YDS will, at its sole option, either: (i) repair the Product(s); (ii) replace the Product(s) with a new or refurbished Product(s) (replacement Product(s) being of identical model or functional equivalent); or (iii) provide you a refund of the price you paid for the Product(s).

This Limited Warranty of YDS is solely limited to repair and/or replacement on the terms set forth above. YDS is not reliable or responsible for any subsequent events.



www.YDSCAM.com sales@ydscam.com Phone (WeChat, QQ): (+86) 177 2732 6718

All rights reserved @ YingDeShun Co. Ltd. Specifications subject to change without notice.



YDS CAMERA MODULE

your best camera partner

YDS Strength

Powerful Factory



Professional Service



Promised Delivery



www.YDSCAM.com sales@ydscam.com Phone (WeChat, QQ): (+86) 177 2732 6718

All rights reserved @ YingDeShun Co. Ltd. Specifications subject to change without notice.